



TECHNICAL DATA

Measurements

Width, head open	1 765 mm
Width, head closed	1 370 mm
Weight (from)	1 910 kg
Height (in processing position)	1 910 mm
Length (in processing position)	1 875 mm
Optimal tree diameter	500 mm
Optimal tree diameter in debarking	350 mm

Delimiting

Number of delimiting knives	4+1
Max opening of front knives	720 mm
Max opening of rear knives	760 mm
Diameter front knives tip-to-tip	480 mm

Feeding

Type of feed	3WD
Diameter of feed rollers	515 mm
Max opening of feed rollers	700 mm

Hydraulics

Recommended pressure min	250 bar
Max pressure	280 bar
Recommend oil flow min	210 l/min
Max oil flow	320 l/min

Electronics

Voltage	24 V
Current	15 A

Recommended base machine

Excavator min weight	18 t
Excavator max weight	30 t
Wheeled harvester min weight	25 t
Wheeled harvester max weight	30 t

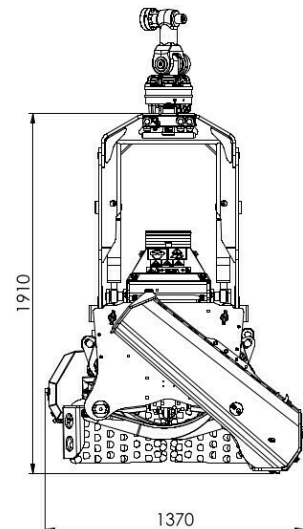
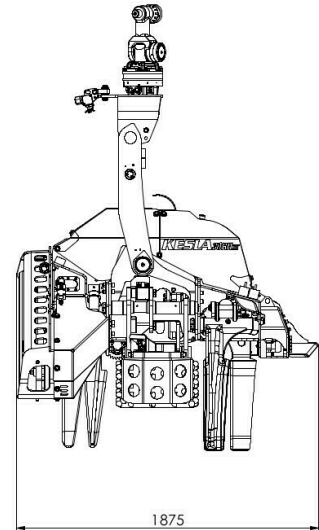
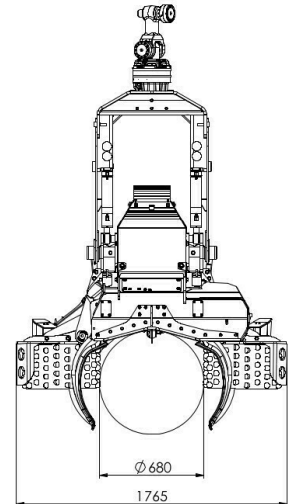

SAW AND FEEDMOTOR CONFIGURATION

Chain Saw Options

JPS R5500 41cc saw with auto chain tensioner & auto saw control

Max cutting diameter	770 mm
Max guide bar length	90 cm
Chain pitch	0.404 "
Saw motor displacement	41 cc
Chain tightener	auto
Saw control	auto

KESLA HD30 with automatic chain tensioner & auto saw control

Max cutting diameter	770 mm
Max guide bar length	90 cm
Chain pitch	0.404 "
Saw motor displacement	30 cc
Chain tightener	auto
Saw control	auto

KESLA HD30 3/4" with auto chain tensioner & auto saw control

Max cutting diameter	770 mm
Max guide bar length	90 cm
Chain pitch	0.75 "
Saw motor displacement	30 cc
Chain tightener	auto
Saw control	auto

Feed Motor Options

Rexroth 820cc

Feed motor displacement	820 cc
Feed force	29.2 kN
Feed speed	5 m/s
Recommended flow	310 l/min
Recommended engine power min	145 kW

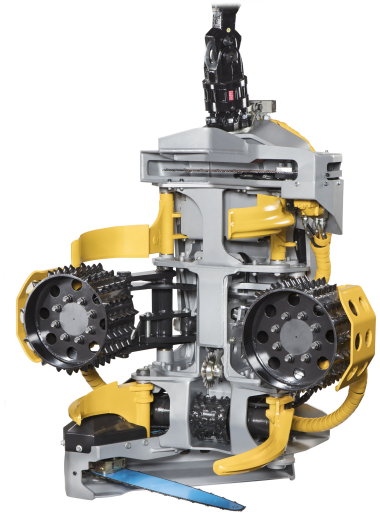

OPTIONAL EQUIPMENT

Control valve

HA01-030-10	STD (mechanical clamping pressure control)
HA01-030-11	KESLA proCON

Saw bar pressure control

HA01-050-10	STD (Manual)
HA01-050-11	Proportional

Tilt control

HA01-055-10	STD tilt
HA01-055-11	proTILT
HA01-055-12	proTILT Lock

Chain oil pump

HA01-060-10	Fixed volume, hydraulic
HA01-060-11	KESLA Prolube, electric adjustable
HA01-060-12	PROLUBE DUAL

Feed roller

HA01-070-10	STD (KESLA steel rollers)
-------------	---------------------------

Middle roller

HA01-080-10	STD
-------------	-----

Length measuring

HA01-090-12	measuring roller KESLA HydCON+
HA01-090-13	KESLA hydCON+ w/ wide sprocket
HA01-090-14	Sensors in feed motors

Diameter measuring

HA01-100-10	No diameter measuring equipment installed
HA01-100-11	STD Analog sensor, current output (mA)
HA01-100-12	Double pulse encoders

Wire harness for control system

HA01-110-10	None
HA01-110-11	Motomit
HA01-110-12	KESLA proLOG or xLogger
HA01-110-13	Dasa d4

Front delimiting knives

HA01-115-10	STD cast knives
HA01-115-11	HD knives (cast)

Pressure accumulators for knives

HA01-120-13	Front & rear knives
HA01-120-14	Front & rear knives (accumulators unpressurized for air freight)

Upper fixed delimiting knife

HA01-130-10	STD (casted knife)
HA01-130-11	SHORT (27RH-II... 30RH-II, welded steel)

Color marking HA01-170-11

Stump treatment HA01-180-11

Control valve for rotator HA01-190-11

Find end sensor HA01-210-11

Spare hose kit HA01-220-11

Spare parts kit

HA01-230-11	STD kit (for a head with measuring wheel)
HA01-230-12	For head with length encoders in feed motors

Tool kit

HA01-240-11	KESLA special tool kit
HA01-240-12	Universal tool kit
HA01-240-13	KESLA special tool kit + Universal tool kit

Rotator & link

HA01-250-11	Black Bruin BBR15HD + link 250 mm w/ dual swing damper (#3160256)
HA01-250-13	Indexator AV 17 (#3160469) + link w/o swing damper (#90019958)
HA01-250-50	Black Bruin RH3016 + 240 mm link w/ dual swing damper
HA01-250-51	Black Bruin RH3016 + 240 mm link w/o swing damper
HA01-250-60	Indexator HX30LS + MPB-link w/ double swing dampers

Control and Measuring System

HA01-260-11	KESLA xLogger with Priority-Bucking software
HA01-260-12	KESLA proLOG
HA01-260-14	KESLA xLogger with Bucking-to-value software

Installation kit for control and measuring system

HA01-270-11

Joystick grips

HA01-280-11	SUREGRIP with 2x10 buttons preset keypads
HA01-280-12	SUREGRIP with 1x10 buttons preset keypad
HA01-280-15	SVAB grips